

1 2 3 4 5 6 7 8

A

B

C

D

E

F

A

B

C

D

E

F

BB0063007

1

2

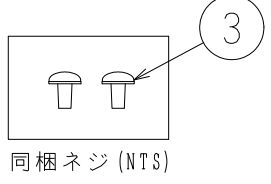
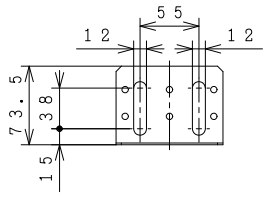
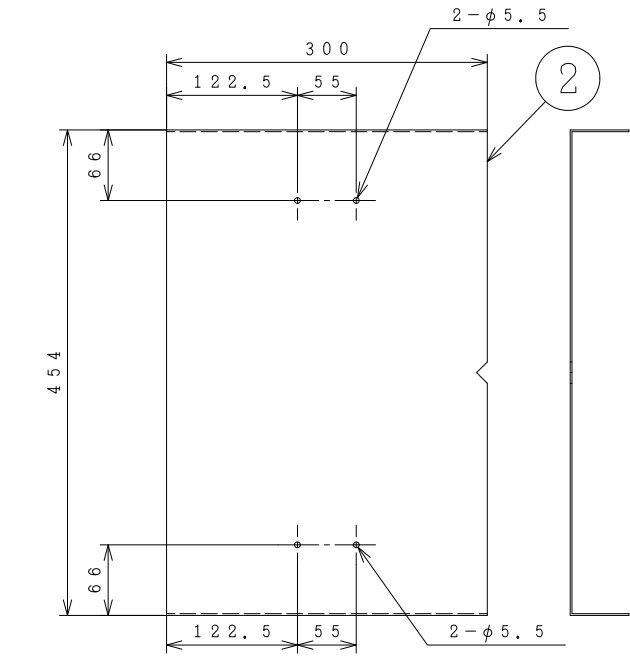
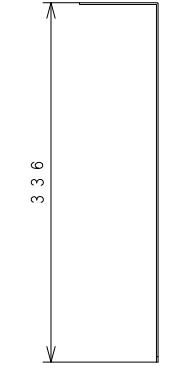

品番	品名	備考
1	本体固定金具	鋼板
2	上部固定金具	鋼板 (貯湯ユニットと同色)
3	取付けネジ (2個)	M6×12

■貯湯ユニットへの組付図

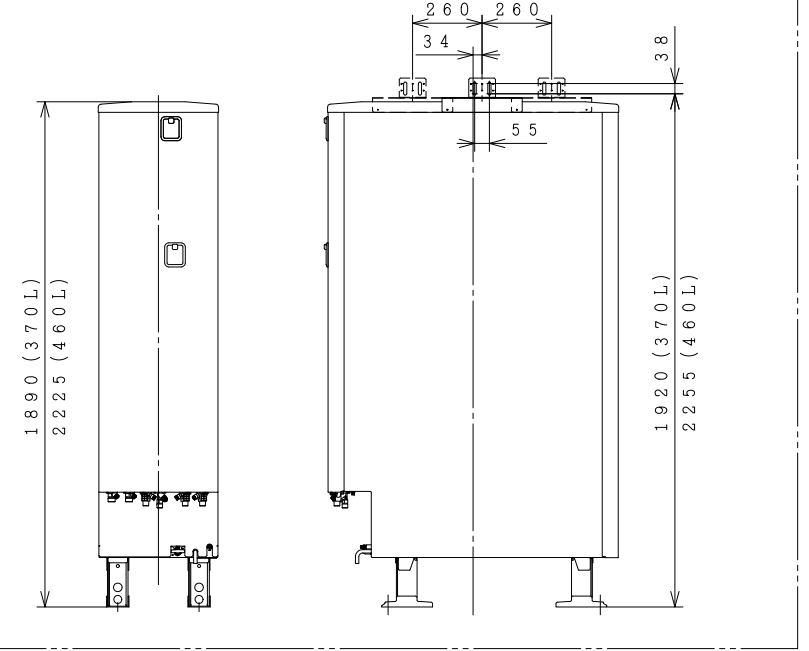
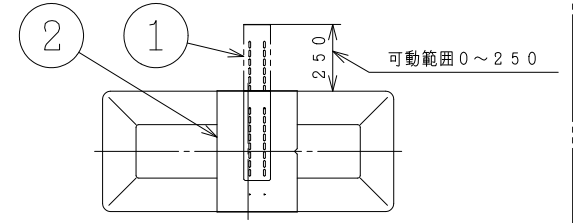

■設置例

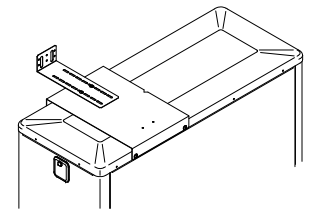

<前側への設置例>

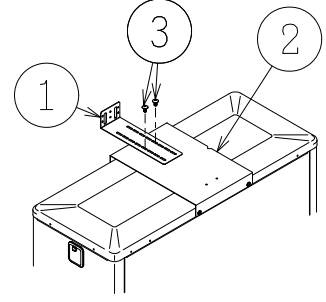

<中央付近への設置例>

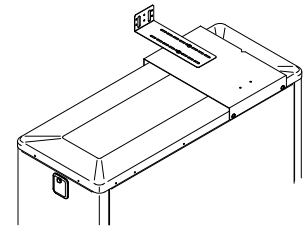

<後側への設置例>

SIGNATURE	DATE	PROJECTION	SCALE	TITLE	CAD
DWN. Y. Koto	2023-01-07		NTS	上部固定金具 (壁固定金具) BEM-1CA 外形寸法図	
CHKD. S. Katagiri	2023-01-11	Hitachi Global Life Solutions, Inc. Tokyo Japan		TOCHIGI DWG. No.	 REGD 2023 0111
APPD. S. Katagiri	2023-01-11	3YAA BB0063007		001	

1 2 3 4 5 6 7 8 0 100 001