

HITACHI
Inspire the Next

日立太陽光発電システム
出力制御ユニット

取扱説明書

保証書 別添付

イーチ エス エス ワイ ディー
型式 **HSS-Y10D**

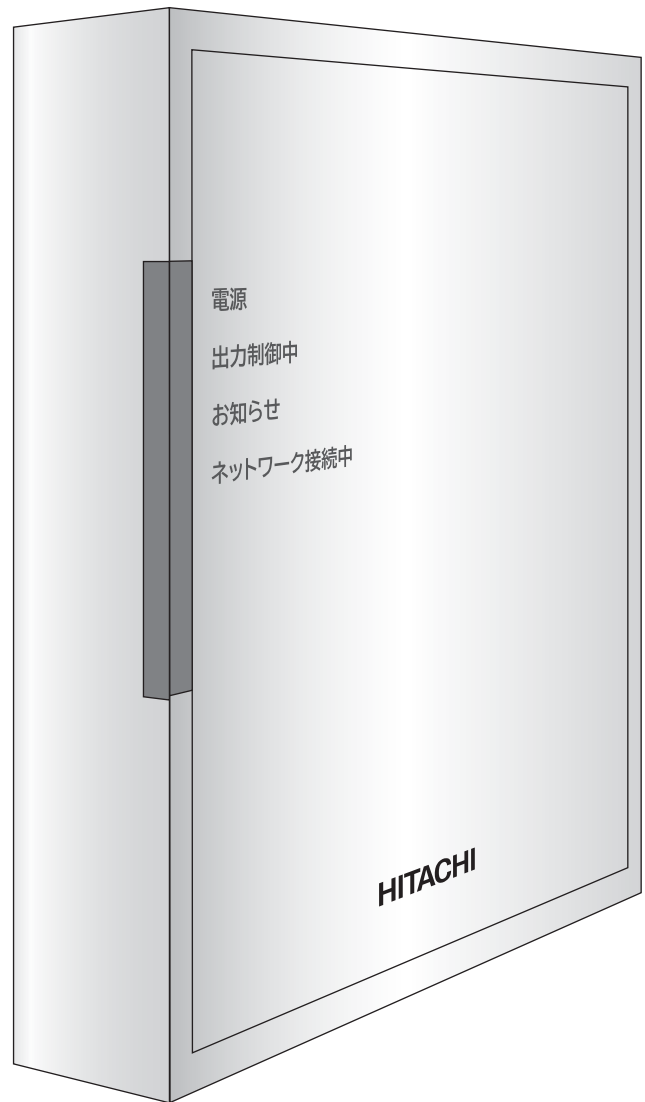

このたびは日立太陽光発電システム 出力制御ユニットをお買い上げいただき、まことにありがとうございました。

この取扱説明書をお読みになり、正しくお使いください。

取扱説明書(本書)、保証書とともに大切に保管してください。

「安全上のご注意」[→ P.6~7](#)をお読みいただき、正しくお使いください。

概要

- 再生可能エネルギー特別措置法施行規則の一部を改正する省令と関連告示（2015年1月22日公布）による遠隔出力制御に対応しています。
- 電力会社からインターネットを介して出力制御の情報を取得し、これに従いパワーコンディショナを制御します。
- 今後正式に発表される遠隔出力制御の仕様によっては、出力制御ユニットのファームウェア（ソフトウェア）の更新が必要となる場合もあります。
- 遠隔出力制御は電力会社の要請により実施されますので、詳細については電力会社にご確認ください。

もくじ



概要	2
各部のなまえ・付属品	4
・出力制御ユニット（本体）	4
・付属品	4
・LEDランプ表示	5
安全上のご注意	6~7
ご使用時の注意点	8
・ご使用前に必ずお読みください	8
・出力制御について	8
・無線通信について	8
設置のしかた	9~10
・固定台への取り付けかた	9
・固定台の外しかた	9
・壁固定のしかた	10
・壁固定後の外しかた	10
各機器との接続	11~16
・インターネット、ACアダプタ接続のしかた	11
・各端子の接続について	12
・パワーコンディショナと接続する場合	13
・センサーユニットと接続する場合	14
・表示ユニット、センサーユニットと接続する場合	15~16
こんなときは	17
インターネット接続について	17
・ソフトウェアの自動更新	17
・発電データ情報の収集	17
保証とアフターサービス	18
ご相談窓口	18
仕様	19
ソフトウェアのライセンス情報	20~30

各部のなまえ・付属品

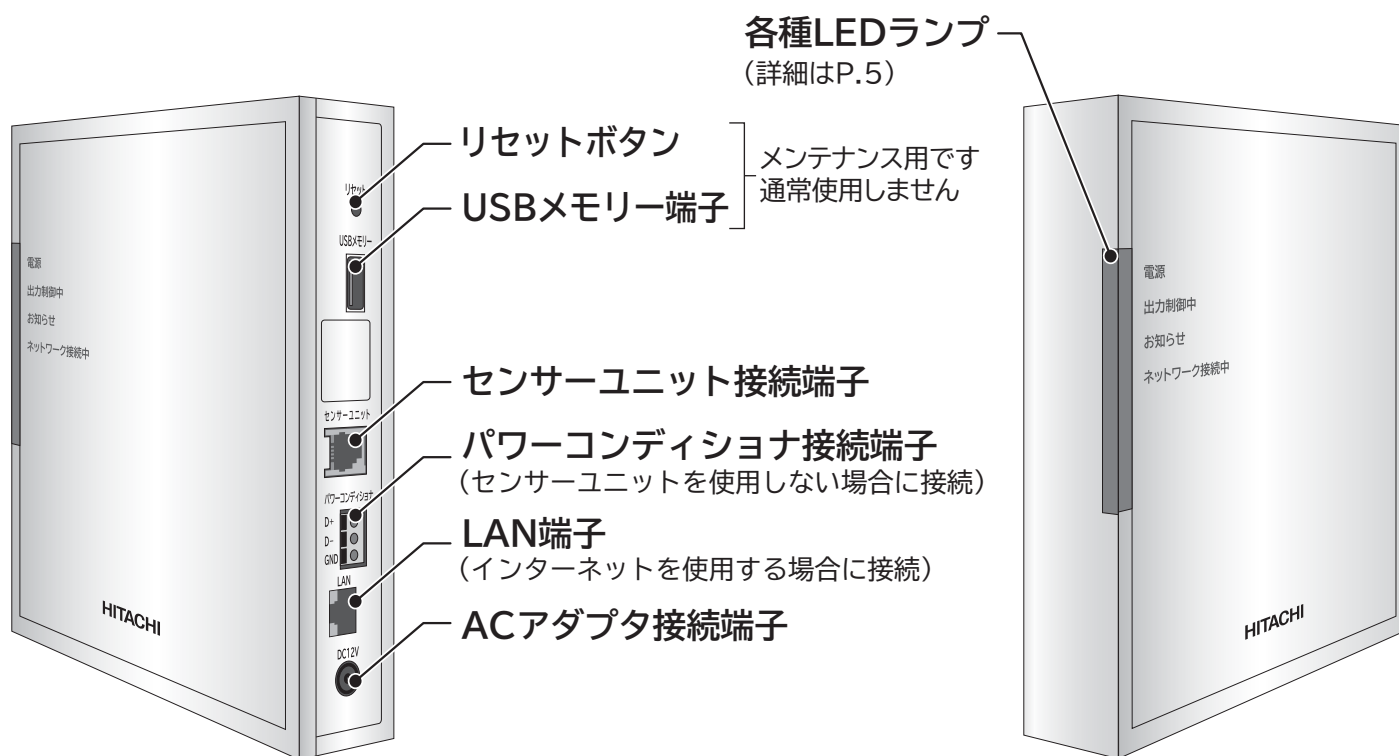
出力制御ユニット (本体)

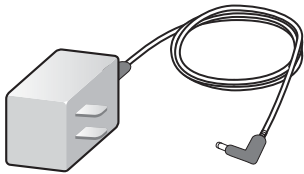

付属品

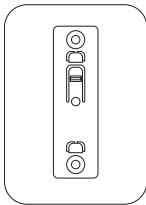
ACアダプタ (KSW1210H)	木ネジ (4×25)	固定台
 <p>1個</p>	 <p>2個</p>	 <p>1個</p>

固定台を本体から外してください

- 固定台を矢印方向に抜く
固定台は本体に取り付けた状態で梱包されています。
固定台を矢印方向にスライドさせて外してください。

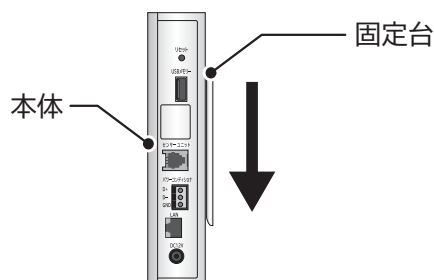

LEDランプ表示

各種LEDランプで本体の状態を知ることができます。

電源

[緑]点灯時は電源が入っている状態です。

出力制御中

[橙]点灯時は発電に制御がかかっている状態です。

お知らせ

[赤]点滅時はお知らせ表示です。「こんなときは」(→P.17)を確認してください。

ネットワーク接続中

[緑]点灯時はインターネットにて電力会社サーバに接続されています。

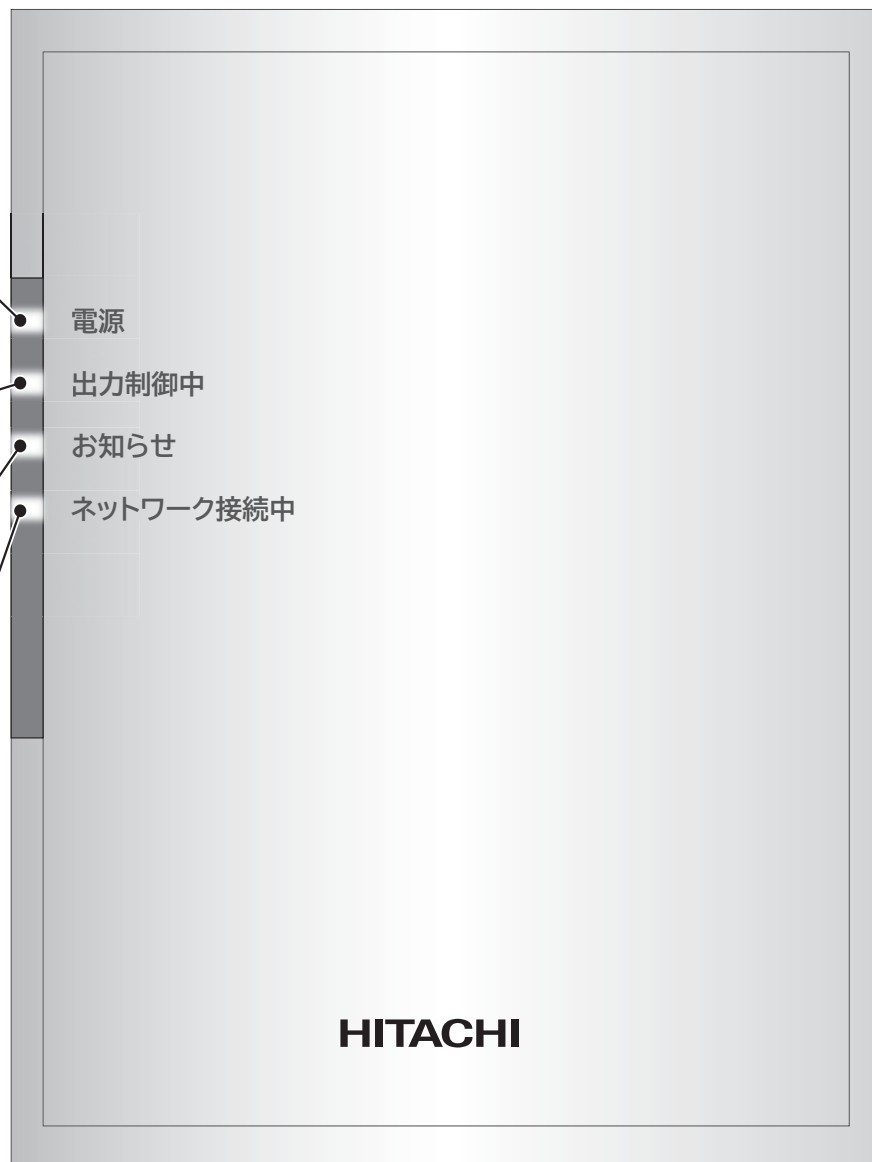

その他ご用意いただくもの





- イーサネットケーブル
LAN端子に接続します。お客様ご使用のインターネット環境にあった長さのものをご用意ください。
- モジュラーケーブル
センサーユニットと接続する場合に使用します。(有線接続する場合)
- 通信用ケーブル(VCTF 3芯)
パワーコンディショナと接続する場合に使用します。

安全上のご注意





お使いになる人や、ほかの人への危害、財産への損害を未然に防止するため、お守りいただくことを、次のように説明しています。また、本文中の注意事項についてもよくお読みのうえ、正しくお使いください。

■ここに示した注意事項は

表示内容を無視して誤った使いかたをしたときに生じる危害や損害の程度を、次の表示で区分し、説明しています。

表示の例	
 警告	この表示の欄は、「死亡または重傷を負うことが想定される」内容です。
 注意	この表示の欄は、「傷害を負うことが想定されるか、または物的損害の発生が想定される」内容です。
	「警告や注意を促す」内容です。
	してはいけない「禁止」内容です。
	実行しなければならない「指示」内容です。

警告

-  ●屋外に設置しない
●高温・多湿・水のかかるおそれがある場所・ホコリの多い場所（車庫・納屋・物置・屋根裏など）に設置しない
火災・感電・漏電・故障の原因となります。
-  ●本体のカバーをはずしたり、分解、改造、取りはずしをしない
火災・感電・漏電・故障の原因となります。
分解禁止
-  ●ぬれた手でさわったり、液体をかけない
ぬれた手でさわったりぬれた布でふいたりしないでください。
本体に液体をかけないでください。
火災・感電・漏電・故障の原因となります。
ぬれ手禁止
- ぬれた手で、ACアダプタの抜き差しはしない
感電の原因となります。
-  ●本体隙間からものを入れない
本体のスリットや各端子の隙間から細長いピン等を入れないでください。
感電・漏電・故障の原因となります。

警告



●ACアダプタは根元まで確実に差し込む

差し込みが不完全ですと、感電や発熱による火災の原因となります。
いたんだACアダプタやゆるんだコンセントは使用しないでください。

●ACアダプタの刃や、刃の取り付け面にほこりが付着したら乾いた布でよくふきとる

ほこりがたまると湿気などで絶縁不良となり、火災の原因となります。
ACアダプタを抜き、乾いた布でふいてください。

●万一、異常が発生したらACアダプタをコンセントから抜く

そのまま使用すると、火災・感電の原因となります。お買い上げの販売店にご相談ください。

●付属のACアダプタを使用する

付属以外のACアダプタを使用すると、火災や焼損、故障の原因となります。



●製品の近くで殺虫剤などの可燃性ガスを使用しない

引火し火災・やけどの原因となります。

●製品の近くで発熱機器や蒸気の出る機器を使用しない

ストーブなどの発熱する機器や炊飯器・加湿器などの蒸気の出る機器を近くで使用しないでください。火災・故障の原因となることがあります。

●ACアダプタやACアダプタのコードは傷つけない。

傷つけたり、無理に引っ張ったり、ねじったり、つぶしたり、挟み込まない。
火災・感電・故障の原因となります。

注意



●高周波ノイズを発生する機器のあるところに設置しない

正常な動作ができなくなることがあります。

●本体を不安定なところに置かない

落下によるけが・故障の原因になります。

●重い物を載せたり、乗ったりしない

けが・故障の原因となります。



●ACアダプタをコンセントから抜くときは、ACアダプタ本体をもって抜く

ACアダプタのコードを引っばると断線やコンセントを傷めたり故障の原因となります。



●お手入れの際は、ACアダプタをコンセントから抜く

感電の原因となります。

プラグを抜く

ご使用時の注意点

ご使用前に必ずお読みください

- ①建物の構造（RC、鉄骨、断熱材のアルミシートなど）等の影響でセンサーユニットや表示ユニット間の電波状態が悪くなる場合があります。出力制御ユニットを屋根裏等に隠蔽設置しないでください。
- ②出力制御ユニットから表示ユニット、センサーユニットへの通信距離の目安は、障害物がない場所での見通し距離で50mです。
- ③出力制御ユニットの電源は常時入れておいてください。電源が切れるとパワーコンディショナは発電を止めます。
- ④インターネットに接続してご使用の場合は、LANケーブルを抜いたりルータ等ネットワーク機器の電源を切ったりしないで常時接続にしてください。

出力制御について

- ①以下の場合には発電が停止しますのでご注意ください。
 - ・出力制御ユニットの電源が切れた場合。
 - ・出力制御ユニットとセンサーユニット間の通信（有線または無線）が途切れた場合。
- ②出力制御ユニットはインターネットに接続して電力会社のサーバから最新の出力制御スケジュール情報を取って制御を行いません。ルータ等ネットワーク機器の電源が切れたり接続ケーブルが抜けたりしてインターネットに接続できないと最新のスケジュール情報が取得できず、発電量が減るおそれがあります。

無線通信について

本製品はセンサーユニット及び表示ユニットと、特定小電力無線を使用して通信を行っているため、次のような場合は注意が必要です。

- ①特定小電力無線は電波法による免許不要の無線であり、自動車用エンジンスターター等にも使用されています。
これらが本製品の近くにある場合、両者の無線通信が干渉し、表示ユニットの表示が頻繁におかしくなる（アンテナマークが「圏外」、表示数値が「0」、または自動車用エンジンスターターが動作しない等）の現象がおこる可能性があります。（表示については表示ユニットの取扱説明書をご覧ください）
これらの現象がおきた場合は、速やかにお買い上げの販売店にご連絡をいただき、無線通信の干渉を防ぐ処置（例えば、周波数の変更など）についてご相談ください。
- ②太陽光発電システムの機器や配線から電氣的雑音が漏れ、近隣のアマチュア無線やラジオなどの通信・受信の障害になることがあります。近隣にアマチュア無線のアンテナがある場合は、お買い上げの販売店にご相談ください。

設置のしかた

固定台への取り付けかた

本体（出力制御ユニット）は固定台へ取り付けて水平な所に置くか、壁に固定してご使用ください。

1 固定台を本体底面に合わせる

- 固定台のツメを本体底面の穴に入れる。その際、右図の様にツメの向きを合わせて挿入してください。

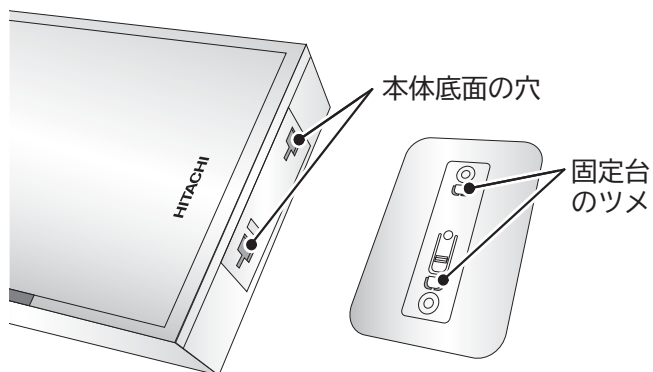

2 固定台を矢印方向に差し込む

- 固定台を矢印方向に「カチッ」というまでスライドさせて差し込んでください。

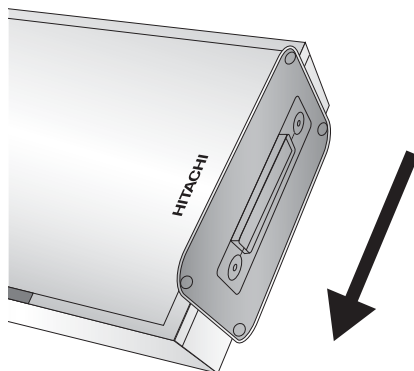

3 水平な所に置いて使用する

- 水平な凹凸のない所（テーブルなど）に置いてご使用ください。

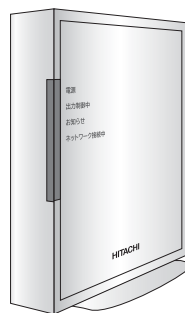

固定台の外しかた

1 固定台を矢印方向に抜く

- 固定台を矢印方向にスライドさせて外してください。

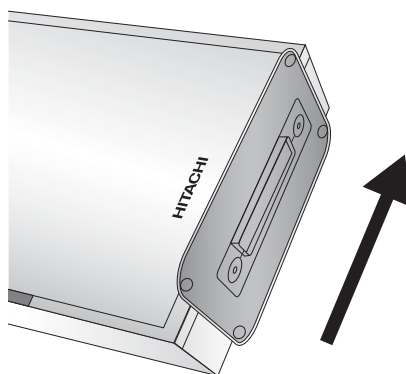

設置のしかた (つづき)

壁固定のしかた

各機器との通信接続可能な範囲で固定する場所を決めてください。
LEDランプが見やすい位置を確認してから設置してください。

1 固定台を付属の木ネジで 壁に固定する

- 木ネジで確実に固定できる十分な強度のある壁面に設置してください。
- 固定する場所を決めて右図のように、固定台をツメが上を向く様に付属の木ネジ (4×25) 2本で壁に固定してください。

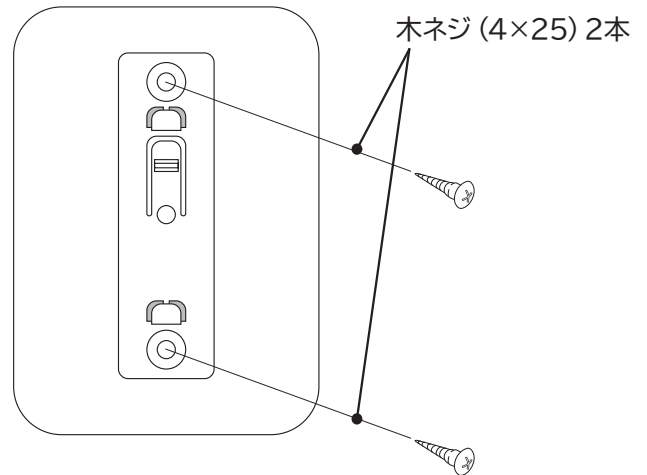

2 本体を矢印方向に差し込む

- 本体後面の穴に固定台のツメを合わせて本体が浮かない様に入れて、矢印方向に「カチッ」というまでスライドさせて差し込んでください。

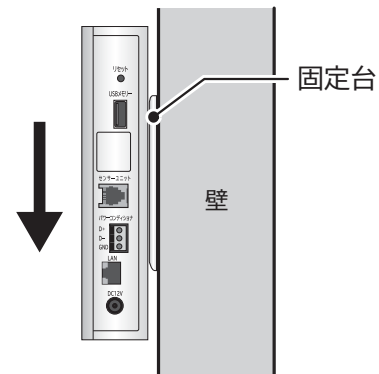

壁固定後の外しかた

1 本体をしっかり持って 矢印の向きに外す

- 本体をしっかり持って矢印の向きにスライドさせて外してください。

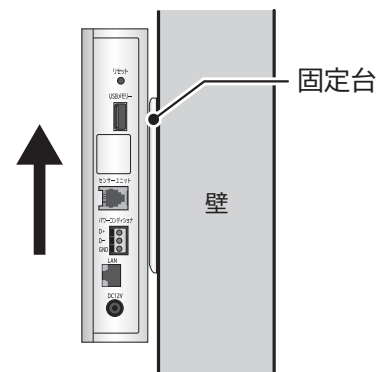

各機器との接続

インターネット、ACアダプタ接続のしかた

1 イーサネットケーブルをLAN端子に接続する

- インターネットに接続してご使用になる場合にはお客様のインターネット環境（ルータ等）からのイーサネットケーブルのツメ部分を図のように端子に合わせて「カチッ」というまで挿入します。

2 ACアダプタを接続する

- ACアダプタを接続し、コンセントに差し込むと全てのLEDランプが約30秒間点灯します（起動準備中）。電源は入れたままにしてください。4分以上電源が切れた状態が続くと発電が止まってしまうのでご注意ください。その場合は電源を再投入することにより発電が再開されます。

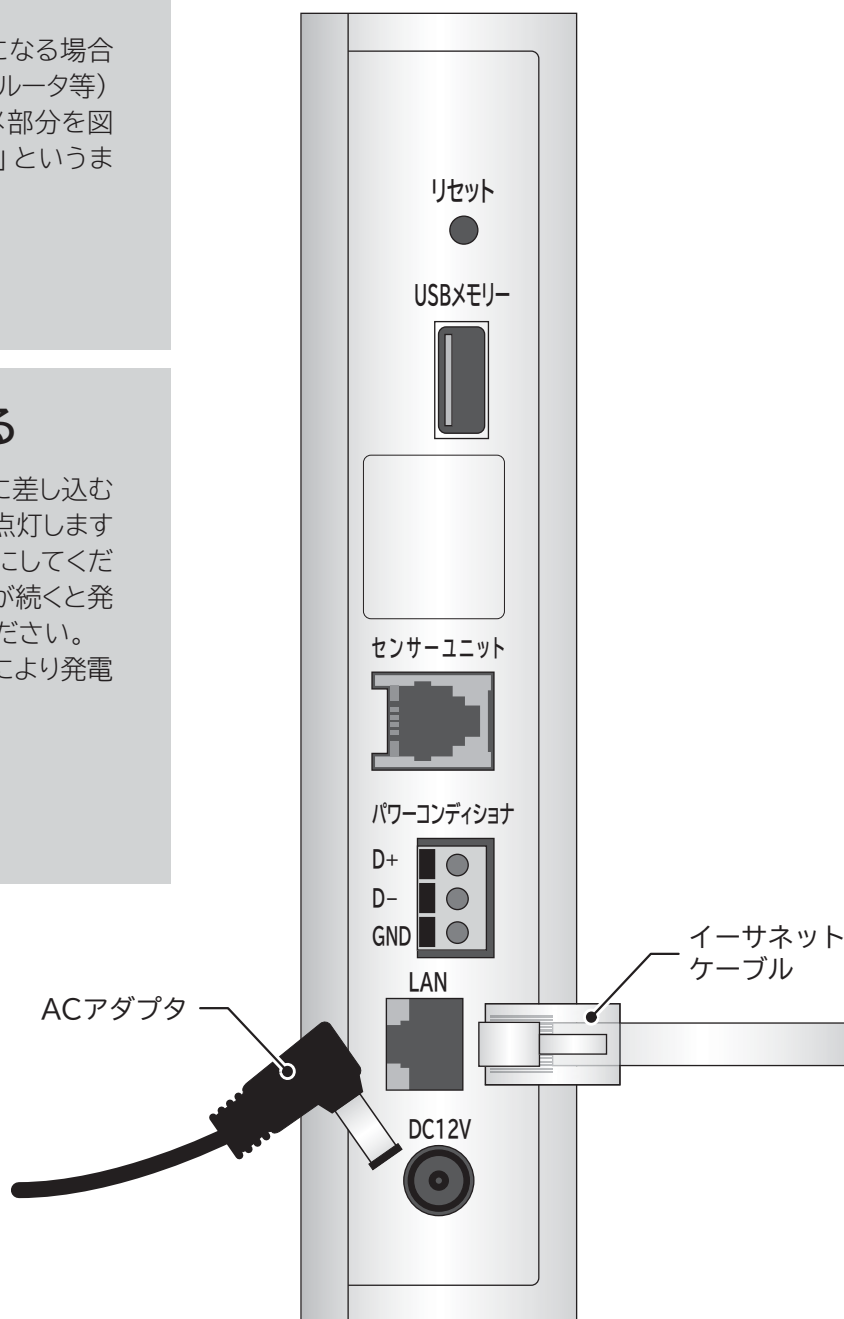

各機器との接続 (つづき)

各端子の接続について

出力制御ユニットは、パワーコンディショナ、表示ユニット、センサーユニットと接続して使用します。用途に応じて以下の組み合わせの接続ができます。

- パワーコンディショナと接続する。
- センサーユニットと接続する。
- 表示ユニット、センサーユニットと接続する。

パワーコンディショナを複数台設置の場合はパワーコンディショナの工事説明書をご覧ください。

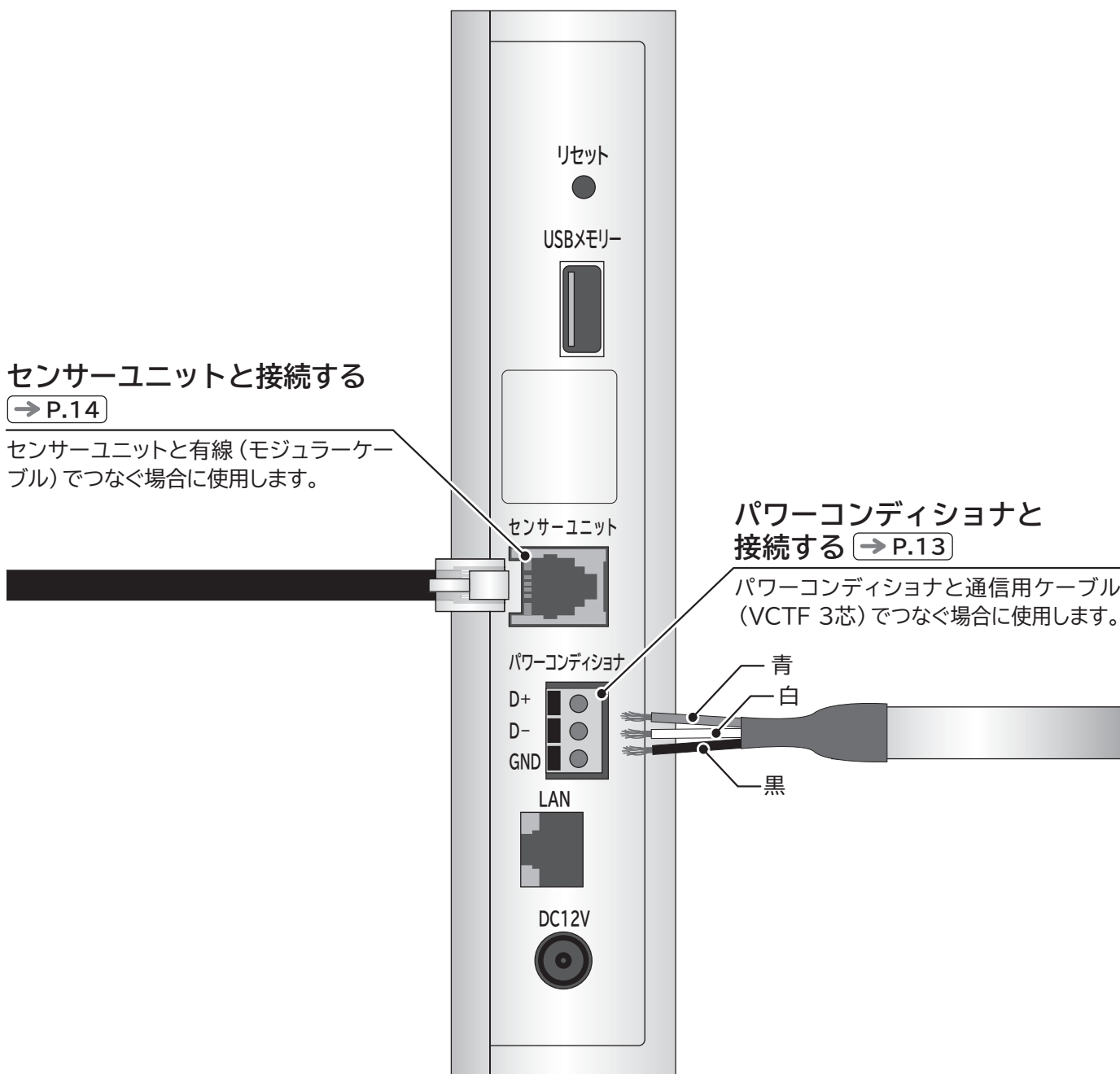

パワーコンディショナと接続する場合

通信用ケーブルでパワーコンディショナと接続します。

接続図

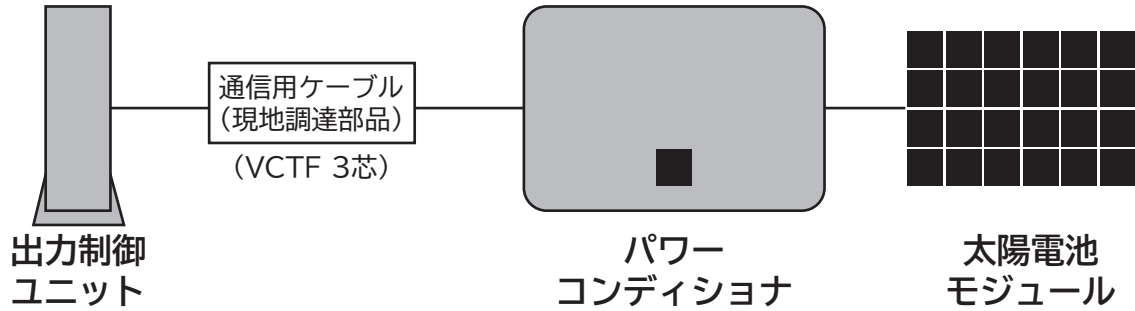

1 通信用ケーブルを
右図のように加工します

シースの皮むき寸法約30mm

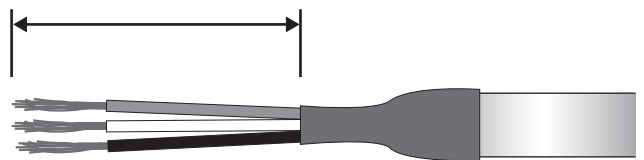

リードの皮むき寸法9~10mm

2 通信用ケーブルを
パワーコンディショナ接続端子に
接続します

- 図のように穴の左の黒いボタンを細いドライバなどで押しながら、より線を挿入してください。線の色はパワーコンディショナ側と合わせて誤挿入しないようにしてください。誤挿入した場合、通信ができなくなります。

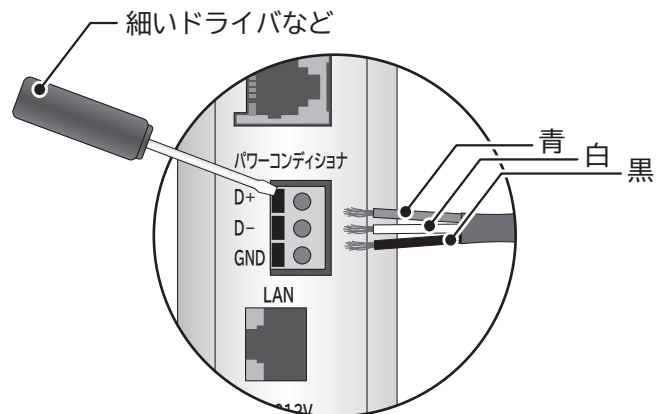

各機器との接続 (つづき)

センサーユニットと接続する場合

無線接続の場合

出力制御ユニットとセンサーユニット間の無線通信は「特定小電力無線局の無線設備」の技術基準に適合しています。通信できる距離は見通し50m程度が目安です。

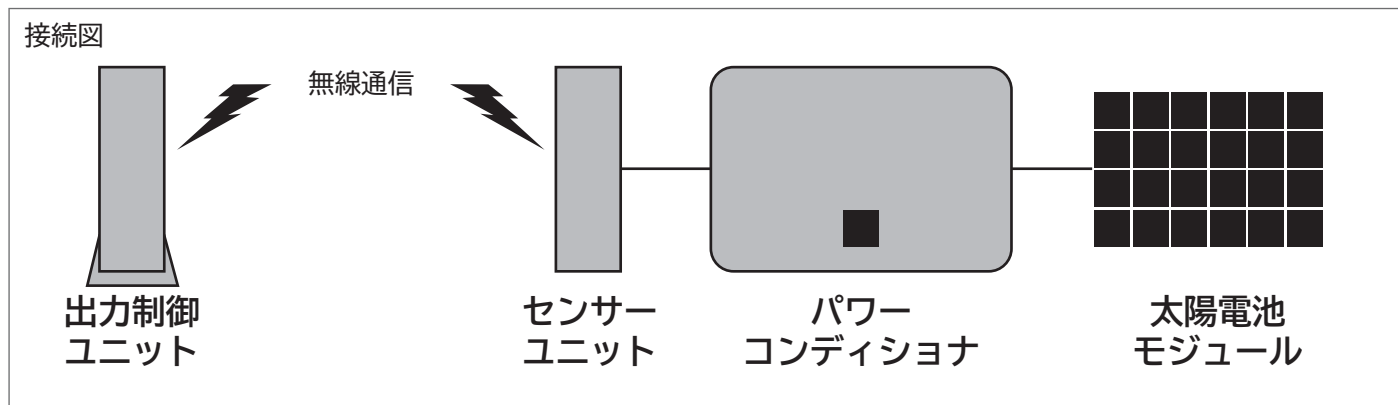

有線接続の場合

モジュラーケーブルでセンサーユニットと接続します。

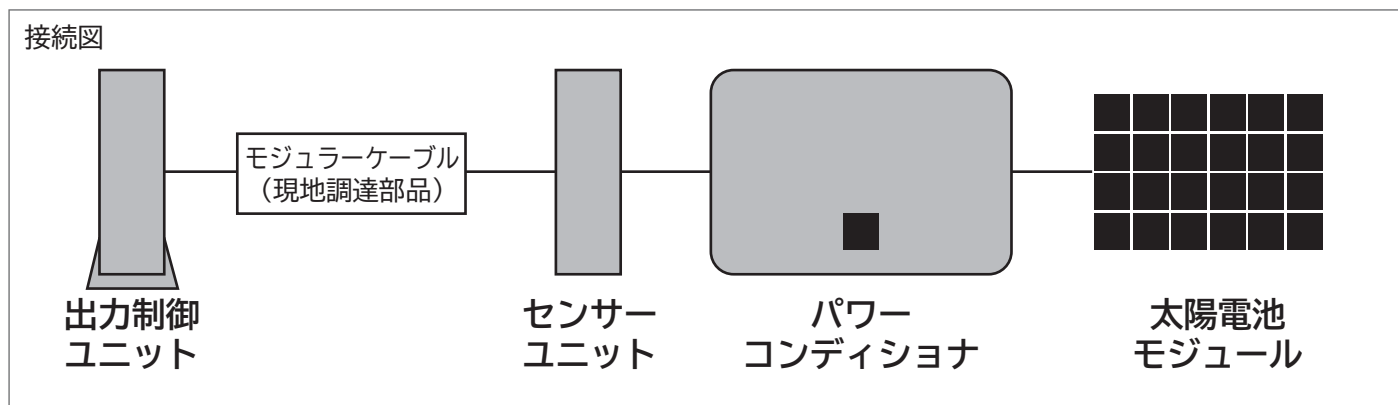

1 モジュラーケーブルをセンサーユニット接続端子に接続する

- モジュラーケーブルのツメ部分を図のように端子に合わせて「カチッ」というまで挿入します。

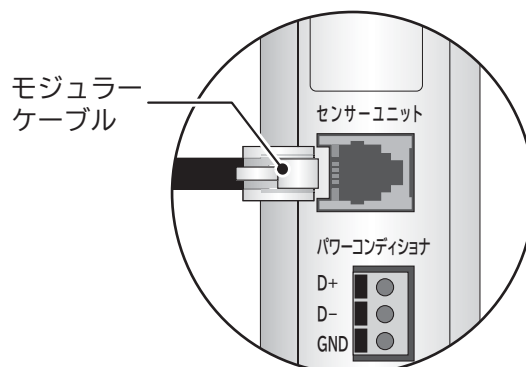

表示ユニット、センサーユニットと接続する場合 出力制御実施時の画面表示について → P.16

無線接続の場合

出力制御ユニットとセンサーユニット及び表示ユニット間の無線通信は「特定小電力無線局の無線設備」の技術基準に適合しています。通信できる距離は見通し50m程度が目安です。

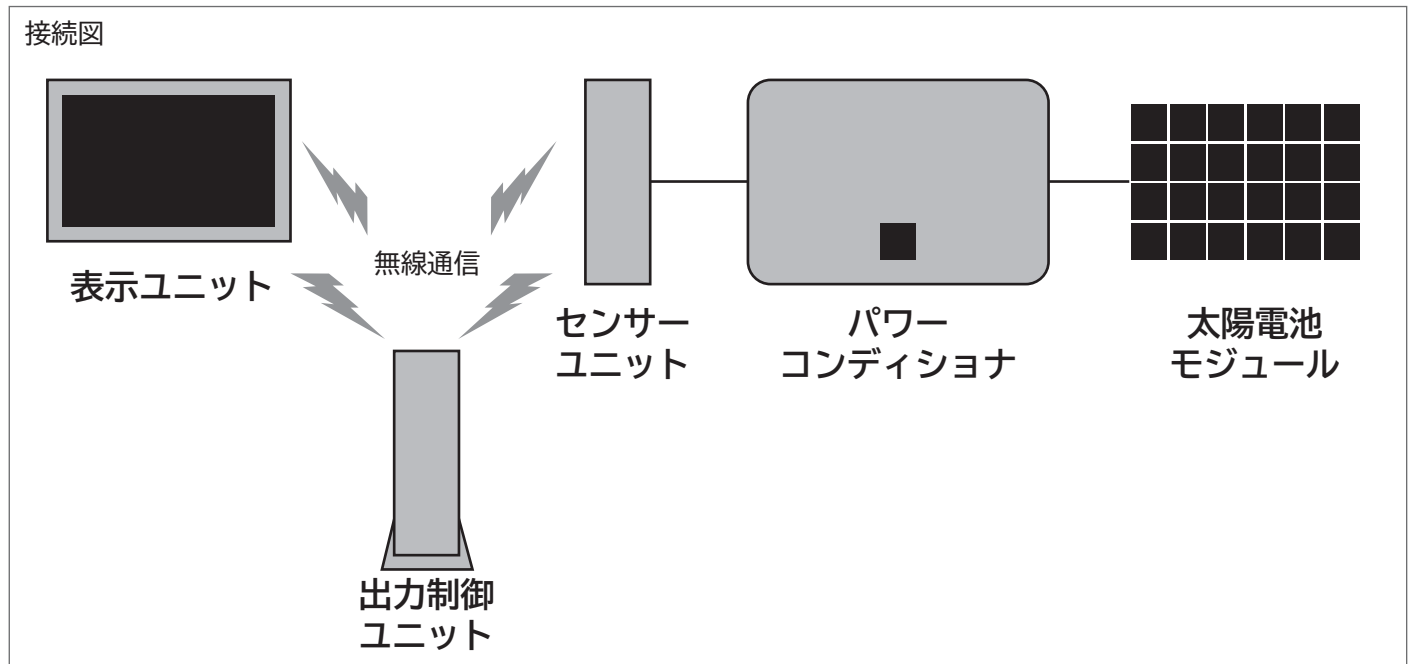

有線接続の場合

モジュラーケーブルでセンサーユニットと接続します。表示ユニット間の通信は無線通信で行います。センサーユニットとの接続のしかたは [→ P.14](#) を確認してください。

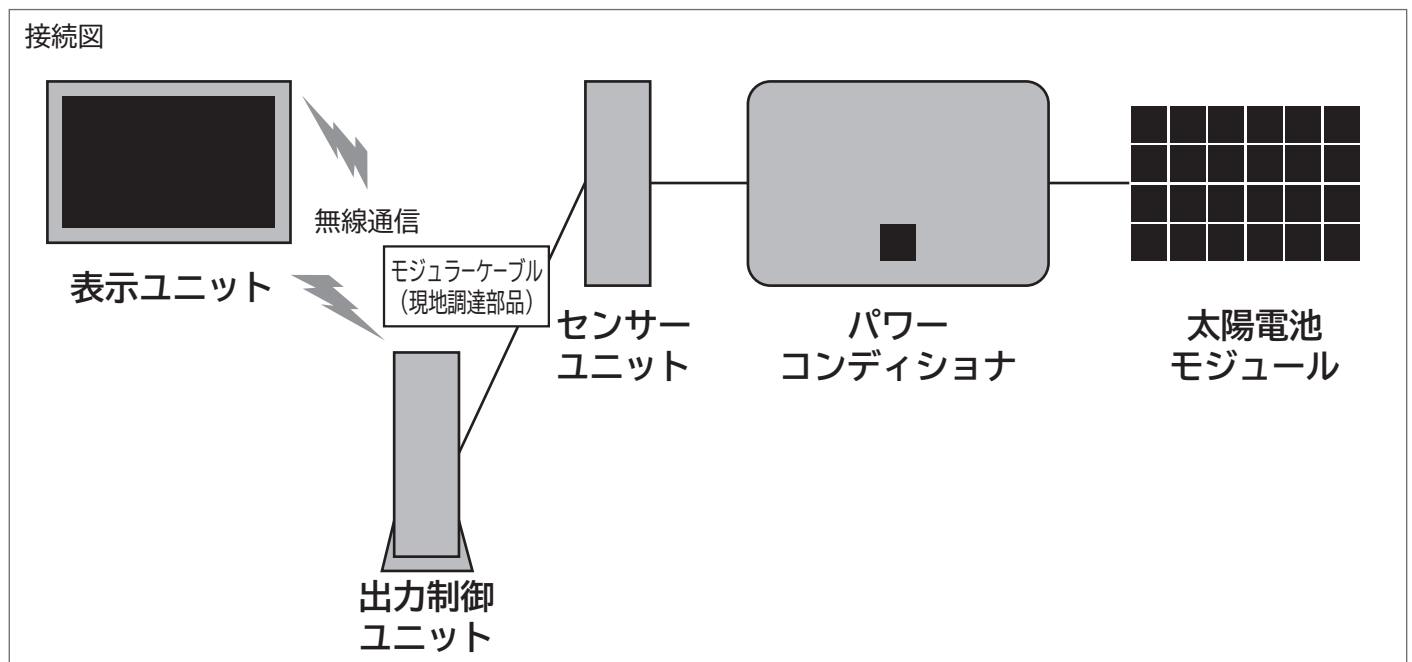

各機器との接続 (つづき)

表示ユニット、センサーユニットと接続する場合 (つづき)

出力制御実施時の画面表示について

電力会社からの出力制御指示が実施されている間、表示ユニットの画面上に、出力制御中を示すメッセージが表示されます。

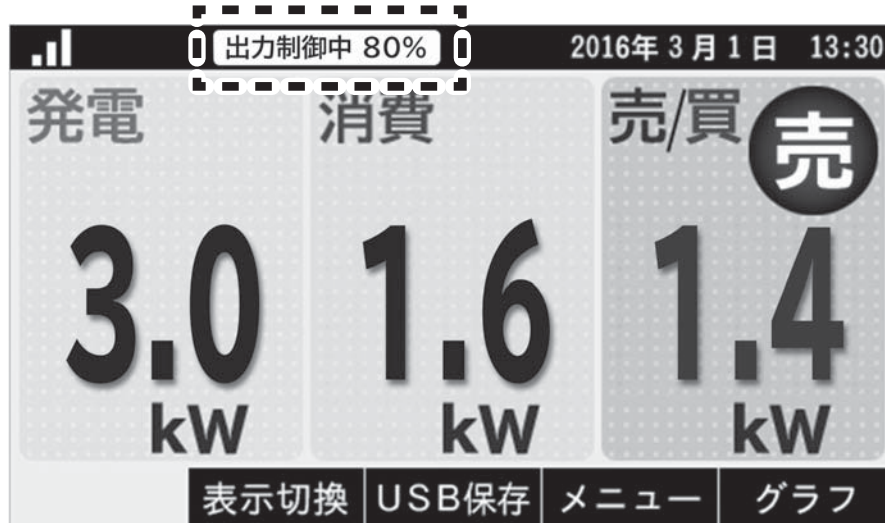

グラフ画面、表画面で過去の出力制御実施状況を確認できます。

グラフ画面



出力制御が発生した時点で▼が表示されます。

表画面 (日単位)

2016年 3月 1日 13:30

	8:00	9:00	10:00	11:00	12:00	13:00	14:00	15:00	
発電	1.6	2.3	2.8	2.9	2.2	2.8	2.3	1.9	
売電	1.2	1.9	2.5	2.7	1.6	2.5	2.2	1.8	
買電	0.0	0.0	0.0	0.0	0.3	0.0	0.0	0.0	
消費	0.4	0.4	0.3	0.2	0.9	0.3	0.1	0.1	
出力制御 (%)	-	-	-	-	-	80	70	70	80
単位:kWh									

ホーム << >> グラフ

表の最下行に出力制御率が表示されます。
(「-」(ハイフン)表示は出力制御なし)

表画面 (月単位)

2016年 3月 1日 13:30

日	月	火	水	木	金	土	
1	15.4	2	15.9	3	17.8	4	17.4
5	16.3	6	16.0	7	13.2	8	15.4
9	15.9	10	13.2	11	15.4	12	15.9
13	16.0	14	15.0	15	15.4	16	16.0
17	16.0	18	17.4	19	16.3	20	16.3
21	15.9	22	17.8	23	17.4	24	16.3
25	15.9	26	17.8	27	16.3	28	13.2
29	15.4	30	16.8	31	16.8		

ホーム ▼売電 <<前の月 次の月>> グラフ

出力制御が実施された日の発電量が朱文字で表示されます。

注意

出力制御実施時刻は、表示ユニットの時刻で保存されるため、実際の実施時刻とのズレが発生する場合があります。

こんなときは

確認してください

LEDランプが全て消灯している

ACアダプタはコンセントにしっかり差し込まれていますか？
ACアダプタの出力制御ユニット側接続部はしっかり差し込まれていますか？
ブレーカーが落ちていませんか？

お知らせLEDランプが
「複数回点滅」を繰り返す

お知らせ表示があるとお知らせLEDランプが「複数回点滅」→「3秒消灯」→「複数回点滅」・・・を繰り返します。点滅回数によって内容が異なります。
以下、点滅回数ごとの対応を試みてもお知らせLEDランプの点滅が1日以上続く様であれば、お買い上げの販売店へお問い合わせください。

2回点滅

弊社サーバとのインターネット通信が正常ではありません。
LAN端子にケーブルが正しく挿入されているか、ルータの電源が切れていないか確認してください。
その後に本体のACアダプタを一度抜いて再投入してください。

3回点滅

センサーユニットとの通信が正常ではありません。
センサーユニットの電源が切れていないか確認してください。
センサーユニットと有線（モジュラーケーブル）で繋いでいる場合は正しく接続されているか確認してください。

4回点滅

電力会社サーバとのインターネット通信が正常ではありません。
LAN端子にケーブルが正しく挿入されているか、ルータの電源が切れていないか確認してください。
その後に本体のACアダプタを一度抜いて再投入してください。

上記以外の点滅

ACアダプタを一度抜いて再投入してください。

煙が出ていたり、
変なにおいがする

ACアダプタをコンセントから抜いてください。
その後、お買い上げの販売店へお問い合わせください。

インターネット接続について

本製品はインターネットで電力会社サーバとの接続以外にも、弊社サーバと接続して以下のサービスを行なっていますのでご了解ください。

ソフトウェアの自動更新

本製品のソフトウェアを弊社サーバよりダウンロードして自動更新する機能があります。今後、予告なくソフトウェアが更新されることがあります。

発電データ情報の収集

今後、アフターサポートのために、お客様の発電データ情報を収集して弊社サーバへアップロードすることがあります。

保証とアフターサービス

必ずお読みください

■保証書(別添付)

保証書は必ず「お引き渡し日・販売店名」などの記入をお確かめのうえ、販売店から受け取っていただき、内容をよくお読みのあと、大切に保管してください。

- 保証期間は、お引き渡し日から開始となります。

■補修用性能部品の保有期間

本製品の補修用性能部品を、製造打ち切り後6年保有しています。

- 補修用性能部品とは、その商品の機能を維持するために必要な部品です。

■部品について

修理の際、弊社の品質基準に適合した再利用部品を使用することがあります。修理のために取り外した部品は、特段のお申し出がない場合、弊社にて引き取らせていただきます。

■ご不明な点や修理に関するご相談は

修理に関するご相談並びにご不明な点は、お買い上げの販売店または下記の「ご相談窓口」にお問い合わせください。

■修理料金の仕組み

修理料金=技術料+部品代+出張料などで構成されています。

技術料	診断、部品交換、調整、修理完了時の点検などの作業にかかる費用です。技術者の人件費、技術教育費、測定機器などの設備費、一般管理費などが含まれます。
部品代	修理に使用した部品代金です。その他修理に付帯する部材等を含む場合もあります。
出張料	製品のある場所へ技術者を派遣する場合の費用です。別途駐車料金をいただく場合があります。

■修理を依頼されるときは 出張修理

「こんなときは」(→P.17)に従って調べていただき、なお異常のあるときはご使用を中止し、ACアダプタをコンセントから抜いてください。

- 保証期間中は

修理に際しましては保証書をご提示ください。保証書の規定に従って、販売店が修理させていただきます。

【ご連絡していただきたい内容】

品名	出力制御ユニット
型式	HSS-Y10D
お引き渡し日	年 月 日
故障の状況	できるだけ具体的に
ご住所	付近の目印等も併せてお知らせください
お名前	
電話番号	
訪問ご希望日	

- 保証期間が過ぎているときは

修理すれば使用できる場合は、ご希望により有料で修理させていただきます。

■ご転居されるときは

ご転居によりお買い上げの販売店のアフターサービスが受けられない場合は、前もって販売店にご相談ください。

ご相談窓口

商品情報や修理はお買い上げの販売店へ

(ご不明な点は、下記窓口にご相談ください)

修理に関するご相談はエコーセンターへ

TEL 0120-3121-68
FAX 0120-3121-87

(受付時間) 9:00~19:00(月~土)、9:00~17:30(日・祝日)
携帯電話、PHSからもご利用できます。

商品情報やお取り扱いについてのご相談は
家電ビジネス情報センターへ

TEL 0120-3121-19
FAX 0120-3121-34

(受付時間) 9:00~17:30(月~土)
日曜・祝日と年末年始・夏期休暇などは休ませていただきます。
携帯電話、PHSからもご利用できます。

- ・「持込修理」および「部品購入」については、上記サービス窓口にて各地区のサービスセンターをご紹介します。
- ・ご相談、ご依頼いただいた内容によっては弊社グループ会社に個人情報を提供し対応させていただくことがあります。
- ・修理をご依頼いただいたお客様へ、アフターサービスに関するアンケートハガキを送付させていただくことがあります。

仕様

品名	出力制御ユニット
型式	HSS-Y10D
定格入力電圧	DC12V
使用温度範囲	動作時:0~40℃
使用湿度範囲	20~90%
最大消費電力	4W
データ通信方法	出力制御ユニットー表示ユニット間:無線通信 出力制御ユニットーセンサーユニット間:無線通信/有線通信 出力制御ユニットーパワーコンディショナ間:有線通信
質量	本体約300g(固定台含む)、ACアダプタ130g
外形寸法	幅131 × 奥行37.5 × 高175mm
設置方法	屋内用(卓上据置/壁面取付固定)
LED表示内容	電源:緑 出力制御中:橙 お知らせ:赤 ネットワーク接続中:緑

ソフトウェアのライセンス情報

本製品に組み込まれたソフトウェアは、複数の独立したソフトウェアモジュールで構成され、個々のソフトウェアモジュールは、それぞれ当社および第三者の著作権が存在します。

本製品には、当社が開発または作成したソフトウェアモジュールも含まれていますが、これらのソフトウェアおよびそれに付帯したドキュメント等には、当社の所有権および知的財産権が存在します。

これらについては、著作権法その他の法律により保護されています。

また、本製品は、米国Free Software Foundation, Inc.が定めたGNU GENERAL PUBLIC LICENSE Version 2 および GNU LESSER GENERAL PUBLIC LICENSE Version 2.1等の「ソフトウェア使用許諾契約書」に基づきフリーソフトウェアとして使用許諾されるソフトウェアモジュールを使用しています。

対象となるソフトウェアモジュールに関しては、下記表を参照してください。また、対象となるソフトウェアモジュールに関するお問い合わせについては、以下のホームページをご覧ください。

URL <http://kadenfan.hitachi.co.jp/afterservice/toiawase.html#03>

当該ソフトウェアモジュールの使用条件等の詳細については、後に記載する各ソフトウェア使用許諾契約書をお読み下さい。(当社以外の第三者による規定であるため、原文(英文)を掲載いたします。)

当該ソフトウェアモジュールについては、当社以外に、別途著作権者その他の権利を有する者がおり、かつ、無償での使用許諾のため、現状のままの提供であり、また、適用法令の範囲内で一切保障(明示するもの、しないものを問いません)をしないものとします。また、当社は、当該ソフトウェアモジュールおよびその使用に関して生じたいかなる損害(データ消失、正確さの喪失、他のプログラムとのインタフェースの不適合化等も含まれます)についても、適用法令の範囲内で一切責任を負わず、費用負担をいたしません。

対象ソフトウェアモジュール	関連ソフトウェア使用許諾契約書
Linux Kernel, u-boot, iptables, busybox	GNU GENERAL PUBLIC LICENSE Version 2
glibc	GNU LESSER GENERAL PUBLIC LICENSE Version 2.1
OpenSSL	OpenSSL License および Original SSLeay License
libupnp	BSD license

■ GNU GENERAL PUBLIC LICENSE Version 2 GNU GENERAL PUBLIC LICENSE Version 2, June 1991

Copyright ©1989,1991 Free Software Foundation, Inc.
51 Franklin St, Fifth Floor, Boston, MA 02110-1301 USA

Everyone is permitted to copy and distribute verbatim copies of this license document, but changing it is not allowed.

Preamble

The licenses for most software are designed to take away your freedom to share and change it. By contrast, the GNU General Public License is intended to guarantee your freedom to share and change free software--to make sure the software is free for all its users. This General Public License applies to most of the Free Software Foundation's software and to any other program whose authors commit to using it. (Some other Free Software Foundation software is covered by the GNU Library General Public License instead.) You can apply it to your programs, too.

When we speak of free software, we are referring to freedom, not price. Our General Public Licenses are designed to make sure that you have the freedom to distribute copies of free software (and charge for this service if you wish), that you

receive source code or can get it if you want it, that you can change the software or use pieces of it in new free programs; and that you know you can do these things.

To protect your rights, we need to make restrictions that forbid anyone to deny you these rights or to ask you to surrender the rights. These restrictions translate to certain responsibilities for you if you distribute copies of the software, or if you modify it.

For example, if you distribute copies of such a program, whether gratis or for a fee, you must give the recipients all the rights that you have. You must make sure that they, too, receive or can get the source code. And you must show them these terms so they know their rights.

We protect your rights with two steps: (1) copyright the software, and (2) offer you this license which gives you legal permission to copy, distribute and/or modify the software.

Also, for each author's protection and ours, we want to make certain that everyone understands that there is no warranty for this free software. If the software is modified by someone else and passed on, we want its recipients to know that what they have is not the original, so that any problems introduced by others will not reflect on the original authors' reputations.

Finally, any free program is threatened constantly by software patents. We wish to avoid the danger that redistributors of a free program will individually obtain patent licenses, in effect making the program proprietary. To prevent this, we have made it clear that any patent must be licensed for everyone's free use or not licensed at all.

The precise terms and conditions for copying, distribution and modification follow.

GNU GENERAL PUBLIC LICENSE TERMS AND CONDITIONS FOR COPYING, DISTRIBUTION AND MODIFICATION

0. This License applies to any program or other work which contains a notice placed by the copyright holder saying it may be distributed under the terms of this General Public License. The "Program", below, refers to any such program or work, and a "work based on the Program" means either the Program or any derivative work under copyright law: that is to say, a work containing the Program or a portion of it, either verbatim or with modifications and/or translated into another language. (Hereinafter, translation is included without limitation in the term "modification".) Each licensee is addressed as "you".

Activities other than copying, distribution and modification are not covered by this License; they are outside its scope. The act of running the Program is not restricted, and the output from the Program is covered only if its contents constitute a work based on the Program (independent of having been made by running the Program). Whether that is true depends on what the Program does.

1. You may copy and distribute verbatim copies of the Program's source code as you receive it, in any medium, provided that you conspicuously and appropriately publish on each copy an appropriate copyright notice and disclaimer of warranty; keep intact all the notices that refer to this License and to the absence of any warranty; and give any other recipients of the Program a copy of this License along with the Program.

You may charge a fee for the physical act of transferring a copy, and you may at your option offer warranty protection in exchange for a fee.

2. You may modify your copy or copies of the Program or any portion of it, thus forming a work based on the Program, and copy and distribute such modifications or work under the terms of Section 1 above, provided that you also meet all of these conditions:

a) You must cause the modified files to carry prominent notices stating that you changed the files and the date of any change.

b) You must cause any work that you distribute or publish, that in whole or in part contains or is derived from the Program or any part thereof, to be licensed as a whole at no charge to all third parties under the terms of this License.

c) If the modified program normally reads commands interactively when run, you must cause it, when started running for such interactive use in the most ordinary way, to print or display an announcement including an appropriate copyright notice and a notice that there is no warranty (or else, saying that you provide a warranty) and that users may redistribute the program under these conditions, and telling the user how to view a copy of this License. (Exception: if the Program itself is interactive but does not normally print such an announcement, your work based on the Program is not required to print an announcement.)

These requirements apply to the modified work as a whole. If identifiable sections of that work are not derived from the Program, and can be reasonably considered independent and separate works in themselves, then this License, and its terms, do not apply to those sections when you distribute them as separate works. But when you distribute the same sections as part of a whole which is a work based on the Program, the distribution of the whole must be on the terms of this License, whose permissions for other licensees extend to the entire whole, and thus to each and every part regardless of who wrote it.

Thus, it is not the intent of this section to claim rights or contest your rights to work written entirely by you; rather, the intent is to exercise the right to control the distribution of derivative or collective works based on the Program.

In addition, mere aggregation of another work not based on the Program with the Program (or with a work based on the Program) on a volume of a storage or distribution medium does not bring the other work under the scope of this License.

3. You may copy and distribute the Program (or a work based on it, under Section 2) in object code or executable form under the terms of Sections 1 and 2 above provided that you also do one of the following:

a) Accompany it with the complete corresponding machine-readable source code, which must be distributed under the terms of Sections 1 and 2 above on a medium customarily used for software interchange; or,

b) Accompany it with a written offer, valid for at least three years, to give any third party, for a charge no more than your cost of physically performing source distribution, a complete machine-readable copy of the corresponding source

code, to be distributed under the terms of Sections 1 and 2 above on a medium customarily used for software interchange; or,

c) Accompany it with the information you received as to the offer to distribute corresponding source code. (This alternative is allowed only for noncommercial distribution and only if you received the program in object code or executable form with such an offer, in accord with Subsection b above.)

The source code for a work means the preferred form of the work for making modifications to it. For an executable work, complete source code means all the source code for all modules it contains, plus any associated interface definition files, plus the scripts used to control compilation and installation of the executable. However, as a special exception, the source code distributed need not include anything that is normally distributed (in either source or binary form) with the major components (compiler, kernel, and so on) of the operating system on which the executable runs, unless that component itself accompanies the executable.

If distribution of executable or object code is made by offering access to copy from a designated place, then offering equivalent access to copy the source code from the same place counts as distribution of the source code, even though third parties are not compelled to copy the source along with the object code.

4. You may not copy, modify, sublicense, or distribute the Program except as expressly provided under this License. Any attempt otherwise to copy, modify, sublicense or distribute the Program is void, and will automatically terminate your rights under this License.

However, parties who have received copies, or rights, from you under this License will not have their licenses terminated so long as such parties remain in full compliance.

5. You are not required to accept this License, since you have not signed it. However, nothing else grants you permission to modify or distribute the Program or its derivative works. These actions are prohibited by law if you do not accept this License. Therefore, by modifying or distributing the Program (or any work based on the Program) , you indicate your acceptance of this License to do so, and all its terms and conditions for copying, distributing or modifying the Program or works based on it.

6. Each time you redistribute the Program (or any work based on the Program) , the recipient automatically receives a license from the original licensor to copy, distribute or modify the Program subject to these terms and conditions. You may not impose any further restrictions on the recipients' exercise of the rights granted herein. You are

not responsible for enforcing compliance by third parties to this License.

7. If, as a consequence of a court judgment or allegation of patent infringement or for any other reason (not limited to patent issues) , conditions are imposed on you (whether by court order, agreement or otherwise) that contradict the conditions of this License, they do not excuse you from the conditions of this License. If you cannot distribute so as to satisfy simultaneously your obligations under this License and any other pertinent obligations, then as a consequence you may not distribute the Program at all.

For example, if a patent license would not permit royalty-free redistribution of the Program by all those who receive copies directly or indirectly through you, then the only way you could satisfy both it and this License would be to refrain entirely from distribution of the Program. If any portion of this section is held invalid or unenforceable under any particular circumstance, the balance of the section is intended to apply and the section as a whole is intended to apply in other circumstances.

It is not the purpose of this section to induce you to infringe any patents or other property right claims or to contest validity of any such claims; this section has the sole purpose of protecting the integrity of the free software distribution system, which is implemented by public license practices. Many people have made generous contributions to the wide range of software distributed through that system in reliance on consistent application of that system; it is up to the author/donor to decide if he or she is willing to distribute software through any other system and a licensee cannot impose that choice.

This section is intended to make thoroughly clear what is believed to be a consequence of the rest of this License.

8. If the distribution and/or use of the Program is restricted in certain countries either by patents or by copyrighted interfaces, the original copyright holder who places the Program under this License may add an explicit geographical distribution limitation excluding those countries, so that distribution is permitted only in or among countries not thus excluded. In such case, this License incorporates the limitation as if written in the body of this License.

9. The Free Software Foundation may publish revised and/or new versions of the General Public License from time to time. Such new versions will be similar in spirit to the present version, but may differ in detail to address new problems or concerns.

Each version is given a distinguishing version number. If the Program specifies a version number of this License which applies to it and "any later

version", you have the option of following the terms and conditions either of that version or of any later version published by the Free Software Foundation. If the Program does not specify a version number of this License, you may choose any version ever published by the Free Software Foundation.

10. If you wish to incorporate parts of the Program into other free programs whose distribution conditions are different, write to the author to ask for permission. For software which is copyrighted by the Free Software Foundation, write to the Free Software Foundation; we sometimes make exceptions for this. Our decision will be guided by the two goals of preserving the free status of all derivatives of our free software and of promoting the sharing and reuse of software generally.

NO WARRANTY

11. BECAUSE THE PROGRAM IS LICENSED FREE OF CHARGE, THERE IS NO WARRANTY FOR THE PROGRAM, TO THE EXTENT PERMITTED BY APPLICABLE LAW. EXCEPT WHEN OTHERWISE STATED IN WRITING THE COPYRIGHT HOLDERS AND/OR OTHER PARTIES PROVIDE THE PROGRAM "AS IS" WITHOUT WARRANTY OF ANY KIND, EITHER EXPRESSED OR IMPLIED, INCLUDING, BUT NOT LIMITED TO, THE IMPLIED WARRANTIES OF MERCHANTABILITY AND FITNESS FOR A PARTICULAR PURPOSE. THE ENTIRE RISK AS TO THE QUALITY AND PERFORMANCE OF THE PROGRAM IS WITH YOU. SHOULD THE PROGRAM PROVE DEFECTIVE, YOU ASSUME THE COST OF ALL NECESSARY SERVICING, REPAIR OR CORRECTION.

12. IN NO EVENT UNLESS REQUIRED BY APPLICABLE LAW OR AGREED TO IN WRITING WILL ANY COPYRIGHT HOLDER, OR ANY OTHER PARTY WHO MAY MODIFY AND/OR REDISTRIBUTE THE PROGRAM AS PERMITTED ABOVE, BE LIABLE TO YOU FOR DAMAGES, INCLUDING ANY GENERAL, SPECIAL, INCIDENTAL OR CONSEQUENTIAL DAMAGES ARISING OUT OF THE USE OR INABILITY TO USE THE PROGRAM (INCLUDING BUT NOT LIMITED TO LOSS OF DATA OR DATA BEING RENDERED INACCURATE OR LOSSES SUSTAINED BY YOU OR THIRD PARTIES OR A FAILURE OF THE PROGRAM TO OPERATE WITH ANY OTHER PROGRAMS) , EVEN IF SUCH HOLDER OR OTHER PARTY HAS BEEN ADVISED OF THE POSSIBILITY OF SUCH DAMAGES.

END OF TERMS AND CONDITIONS

How to Apply These Terms to Your New Programs

If you develop a new program, and you want it to be of the greatest possible use to the public, the best way to achieve this is to make it free software which everyone can redistribute and change under these terms.

To do so, attach the following notices to the program. It is safest to attach them to the start of each source file to most effectively convey the exclusion of warranty; and each file should have at least the "copyright" line and a pointer to where the full notice is found.

<one line to give the program's name and a brief idea of what it does.>

Copyright © <year> <name of author>

This program is free software; you can redistribute it and/or modify it under the terms of the GNU General Public License as published by the Free Software Foundation; either version 2 of the License, or (at your option) any later version.

This program is distributed in the hope that it will be useful, but WITHOUT ANY WARRANTY; without even the implied warranty of MERCHANTABILITY or FITNESS FOR A PARTICULAR PURPOSE. See the GNU General Public License for more details.

You should have received a copy of the GNU General Public License along with this program; if not, write to the Free Software Foundation, Inc., 51 Franklin St, Fifth Floor, Boston, MA 02110-1301 USA

Also add information on how to contact you by electronic and paper mail.

If the program is interactive, make it output a short notice like this when it starts in an interactive mode:

Gnomovision version 69, Copyright © year name of author Gnomovision comes with ABSOLUTELY NO WARRANTY; for details type `show w'. This is free software, and you are welcome to redistribute it under certain conditions; type `show c' for details.

The hypothetical commands `show w' and `show c' should show the appropriate parts of the General Public License. Of course, the commands you use may be called something other than `show w' and `show c'; they could even be mouse-clicks or menu items--whatever suits your program.

You should also get your employer (if you work as a programmer) or your school, if any, to sign a "copyright disclaimer" for the program, if necessary. Here is a sample; alter the names:

Yoyodyne, Inc., hereby disclaims all copyright interest in the program `Gnomovision' (which makes passes at compilers) written by James Hacker.

<signature of Ty Coon> , 1 April 1989
Ty Coon, President of Vice

This General Public License does not permit incorporating your program into proprietary

programs. If your program is a subroutine library, you may consider it more useful to permit linking proprietary applications with the library. If this is what you want to do, use the GNU Library General Public License instead of this License.

■ GNU LESSER GENERAL PUBLIC LICENSE Version 2.1
GNU LESSER GENERAL PUBLIC LICENSE
Version 2.1, February 1999

Copyright © 1991, 1999 Free Software Foundation, Inc. 51 Franklin Street, Fifth Floor, Boston, MA 02110-1301 USA

Everyone is permitted to copy and distribute verbatim copies of this license document, but changing it is not allowed.

[This is the first released version of the Lesser GPL. It also counts as the successor of the GNU Library Public License, version 2, hence the version number 2.1.]

Preamble

The licenses for most software are designed to take away your freedom to share and change it. By contrast, the GNU General Public Licenses are intended to guarantee your freedom to share and change free software--to make sure the software is free for all its users.

This license, the Lesser General Public License, applies to some specially designated software packages--typically libraries--of the Free Software Foundation and other authors who decide to use it. You can use it too, but we suggest you first think carefully about whether this license or the ordinary General Public License is the better strategy to use in any particular case, based on the explanations below.

When we speak of free software, we are referring to freedom of use, not price. Our General Public Licenses are designed to make sure that you have the freedom to distribute copies of free software (and charge for this service if you wish); that you receive source code or can get it if you want it; that you can change the software and use pieces of it in new free programs; and that you are informed that you can do these things.

To protect your rights, we need to make restrictions that forbid distributors to deny you these rights or to ask you to surrender these rights. These restrictions translate to certain responsibilities for you if you distribute copies of the library or if you modify it.

For example, if you distribute copies of the library,

whether gratis or for a fee, you must give the recipients all the rights that we gave you. You must make sure that they, too, receive or can get the source code. If you link other code with the library, you must provide complete object files to the recipients, so that they can relink them with the library after making changes to the library and recompiling it. And you must show them these terms so they know their rights.

We protect your rights with a two-step method: (1) we copyright the library, and (2) we offer you this license, which gives you legal permission to copy, distribute and/or modify the library.

To protect each distributor, we want to make it very clear that there is no warranty for the free library. Also, if the library is modified by someone else and passed on, the recipients should know that what they have is not the original version, so that the original author's reputation will not be affected by problems that might be introduced by others.

Finally, software patents pose a constant threat to the existence of any free program. We wish to make sure that a company cannot effectively restrict the users of a free program by obtaining a restrictive license from a patent holder. Therefore, we insist that any patent license obtained for a version of the library must be consistent with the full freedom of use specified in this license.

Most GNU software, including some libraries, is covered by the ordinary GNU General Public License. This license, the GNU Lesser General Public License, applies to certain designated libraries, and is quite different from the ordinary General Public License. We use this license for certain libraries in order to permit linking those libraries into non-free programs.

When a program is linked with a library, whether statically or using a shared library, the combination of the two is legally speaking a combined work, a derivative of the original library. The ordinary General Public License therefore permits such linking only if the entire combination fits its criteria of freedom. The Lesser General Public License permits more lax criteria for linking other code with the library.

We call this license the "Lesser" General Public License because it does Less to protect the user's freedom than the ordinary General Public License. It also provides other free software developers Less of an advantage over competing non-free programs. These disadvantages are the reason we use the ordinary General Public License for many libraries. However, the Lesser license provides advantages in certain special circumstances.

For example, on rare occasions, there may be a special need to encourage the widest possible use

of a certain library, so that it becomes a de-facto standard. To achieve this, non-free programs must be allowed to use the library. A more frequent case is that a free library does the same job as widely used non-free libraries. In this case, there is little to gain by limiting the free library to free software only, so we use the Lesser General Public License.

In other cases, permission to use a particular library in non-free programs enables a greater number of people to use a large body of free software. For example, permission to use the GNU C Library in non-free programs enables many more people to use the whole GNU operating system, as well as its variant, the GNU/Linux operating system.

Although the Lesser General Public License is less protective of the users' freedom, it does ensure that the user of a program that is linked with the Library has the freedom and the wherewithal to run that program using a modified version of the Library.

The precise terms and conditions for copying, distribution and modification follow. Pay close attention to the difference between a "work based on the library" and a "work that uses the library". The former contains code derived from the library, whereas the latter must be combined with the library in order to run.

GNU LESSER GENERAL PUBLIC LICENSE TERMS AND CONDITIONS FOR COPYING, DISTRIBUTION AND MODIFICATION

0. This License Agreement applies to any software library or other program which contains a notice placed by the copyright holder or other authorized party saying it may be distributed under the terms of this Lesser General Public License (also called "this License") . Each licensee is addressed as "you".

A "library" means a collection of software functions and/or data prepared so as to be conveniently linked with application programs (which use some of those functions and data) to form executables.

The "Library", below, refers to any such software library or work which has been distributed under these terms. A "work based on the Library" means either the Library or any derivative work under copyright law: that is to say, a work containing the Library or a portion of it, either verbatim or with modifications and/or translated straightforwardly into another language. (Hereinafter, translation is included without limitation in the term "modification".)

"Source code" for a work means the preferred form of the work for making modifications to it. For a library, complete source code means all the source code for all modules it contains, plus any associated interface definition files, plus the scripts used to

control compilation and installation of the library.

Activities other than copying, distribution and modification are not covered by this License; they are outside its scope. The act of running a program using the Library is not restricted, and output from such a program is covered only if its contents constitute a work based on the Library (independent of the use of the Library in a tool for writing it) . Whether that is true depends on what the Library does and what the program that uses the Library does.

1. You may copy and distribute verbatim copies of the Library's complete source code as you receive it, in any medium, provided that you conspicuously and appropriately publish on each copy an appropriate copyright notice and disclaimer of warranty; keep intact all the notices that refer to this License and to the absence of any warranty; and distribute a copy of this License along with the Library.

You may charge a fee for the physical act of transferring a copy, and you may at your option offer warranty protection in exchange for a fee.

2. You may modify your copy or copies of the Library or any portion of it, thus forming a work based on the Library, and copy and distribute such modifications or work under the terms of Section 1 above, provided that you also meet all of these conditions:

a) The modified work must itself be a software library.

b) You must cause the files modified to carry prominent notices stating that you changed the files and the date of any change.

c) You must cause the whole of the work to be licensed at no charge to all third parties under the terms of this License.

d) If a facility in the modified Library refers to a function or a table of data to be supplied by an application program that uses the facility, other than as an argument passed when the facility is invoked, then you must make a good faith effort to ensure that, in the event an application does not supply such function or table, the facility still operates, and performs whatever part of its purpose remains meaningful.

(For example, a function in a library to compute square roots has a purpose that is entirely well-defined independent of the application. Therefore, Subsection 2d requires that any application-supplied function or table used by this function must be optional: if the application does not supply it, the square root function must still compute square roots.)

These requirements apply to the modified work as a whole. If identifiable sections of that work are not derived from the Library, and can be reasonably considered independent and separate works in themselves, then this License, and its terms, do not apply to those sections when you distribute them as separate works. But when you distribute the same sections as part of a whole which is a work based on the Library, the distribution of the whole must be on the terms of this License, whose permissions for other licensees extend to the entire whole, and thus to each and every part regardless of who wrote it.

Thus, it is not the intent of this section to claim rights or contest your rights to work written entirely by you; rather, the intent is to exercise the right to control the distribution of derivative or collective works based on the Library.

In addition, mere aggregation of another work not based on the Library with the Library (or with a work based on the Library) on a volume of a storage or distribution medium does not bring the other work under the scope of this License.

3. You may opt to apply the terms of the ordinary GNU General Public License instead of this License to a given copy of the Library. To do this, you must alter all the notices that refer to this License, so that they refer to the ordinary GNU General Public License, version 2, instead of to this License. (If a newer version than version 2 of the ordinary GNU General Public License has appeared, then you can specify that version instead if you wish.) Do not make any other change in these notices.

Once this change is made in a given copy, it is irreversible for that copy, so the ordinary GNU General Public License applies to all subsequent copies and derivative works made from that copy.

This option is useful when you wish to copy part of the code of the Library into a program that is not a library.

4. You may copy and distribute the Library (or a portion or derivative of it, under Section 2) in object code or executable form under the terms of Sections 1 and 2 above provided that you accompany it with the complete corresponding machine-readable source code, which must be distributed under the terms of Sections 1 and 2 above on a medium customarily used for software interchange.

If distribution of object code is made by offering access to copy from a designated place, then offering equivalent access to copy the source code from the same place satisfies the requirement to distribute the source code, even though third parties are not compelled to copy the source along with the object code.

5. A program that contains no derivative of any portion of the Library, but is designed to work with the Library by being compiled or linked with it, is called a "work that uses the Library". Such a work, in isolation, is not a derivative work of the Library, and therefore falls outside the scope of this License.

However, linking a "work that uses the Library" with the Library creates an executable that is a derivative of the Library (because it contains portions of the Library), rather than a "work that uses the library". The executable is therefore covered by this License. Section 6 states terms for distribution of such executables.

When a "work that uses the Library" uses material from a header file that is part of the Library, the object code for the work may be a derivative work of the Library even though the source code is not. Whether this is true is especially significant if the work can be linked without the Library, or if the work is itself a library. The threshold for this to be true is not precisely defined by law.

If such an object file uses only numerical parameters, data structure layouts and accessors, and small macros and small inline functions (ten lines or less in length), then the use of the object file is unrestricted, regardless of whether it is legally a derivative work. (Executables containing this object code plus portions of the Library will still fall under Section 6.)

Otherwise, if the work is a derivative of the Library, you may distribute the object code for the work under the terms of Section 6. Any executables containing that work also fall under Section 6, whether or not they are linked directly with the Library itself.

6. As an exception to the Sections above, you may also combine or link a "work that uses the Library" with the Library to produce a work containing portions of the Library, and distribute that work under terms of your choice, provided that the terms permit modification of the work for the customer's own use and reverse engineering for debugging such modifications.

You must give prominent notice with each copy of the work that the Library is used in it and that the Library and its use are covered by this License. You must supply a copy of this License. If the work during execution displays copyright notices, you must include the copyright notice for the Library among them, as well as a reference directing the user to the copy of this License. Also, you must do one of these things:

a) Accompany the work with the complete

corresponding machine-readable source code for the Library including whatever changes were used in the work (which must be distributed under Sections 1 and 2 above) ; and, if the work is an executable linked with the Library, with the complete machine-readable "work that uses the Library", as object code and/or source code, so that the user can modify the Library and then relink to produce a modified executable containing the modified Library. (It is understood that the user who changes the contents of definitions files in the Library will not necessarily be able to recompile the application to use the modified definitions.)

b) Use a suitable shared library mechanism for linking with the Library. A suitable mechanism is one that (1) uses at run time a copy of the library already present on the user's computer system, rather than copying library functions into the executable, and (2) will operate properly with a modified version of the library, if the user installs one, as long as the modified version is interface-compatible with the version that the work was made with.

c) Accompany the work with a written offer, valid for at least three years, to give the same user the materials specified in Subsection 6a, above, for a charge no more than the cost of performing this distribution.

d) If distribution of the work is made by offering access to copy from a designated place, offer equivalent access to copy the above specified materials from the same place.

e) Verify that the user has already received a copy of these materials or that you have already sent this user a copy.

For an executable, the required form of the "work that uses the Library" must include any data and utility programs needed for reproducing the executable from it. However, as a special exception, the materials to be distributed need not include anything that is normally distributed (in either source or binary form) with the major components (compiler, kernel, and so on) of the operating system on which the executable runs, unless that component itself accompanies the executable.

It may happen that this requirement contradicts the license restrictions of other proprietary libraries that do not normally accompany the operating system. Such a contradiction means you cannot use both them and the Library together in an executable that you distribute.

7. You may place library facilities that are a work based on the Library side-by-side in a single library together with other library facilities not covered by this License, and distribute such a combined library, provided that the separate distribution of the

work based on the Library and of the other library facilities is otherwise permitted, and provided that you do these two things:

a) Accompany the combined library with a copy of the same work based on the Library, uncombined with any other library facilities. This must be distributed under the terms of the Sections above.

b) Give prominent notice with the combined library of the fact that part of it is a work based on the Library, and explaining where to find the accompanying uncombined form of the same work.

8. You may not copy, modify, sublicense, link with, or distribute the Library except as expressly provided under this License. Any attempt otherwise to copy, modify, sublicense, link with, or distribute the Library is void, and will automatically terminate your rights under this License. However, parties who have received copies, or rights, from you under this License will not have their licenses terminated so long as such parties remain in full compliance.

9. You are not required to accept this License, since you have not signed it. However, nothing else grants you permission to modify or distribute the Library or its derivative works. These actions are prohibited by law if you do not accept this License. Therefore, by modifying or distributing the Library (or any work based on the Library) , you indicate your acceptance of this License to do so, and all its terms and conditions for copying, distributing or modifying the Library or works based on it.

10. Each time you redistribute the Library (or any work based on the Library) , the recipient automatically receives a license from the original licensor to copy, distribute, link with or modify the Library subject to these terms and conditions. You may not impose any further restrictions on the recipients' exercise of the rights granted herein. You are not responsible for enforcing compliance by third parties with this License.

11. If, as a consequence of a court judgment or allegation of patent infringement or for any other reason (not limited to patent issues) , conditions are imposed on you (whether by court order, agreement or otherwise) that contradict the conditions of this License, they do not excuse you from the conditions of this License. If you cannot distribute so as to satisfy simultaneously your obligations under this License and any other pertinent obligations, then as a consequence you may not distribute the Library at all. For example, if a patent license would not permit royalty-free redistribution of the Library by all those who receive copies directly or indirectly through you, then the only way you could satisfy both it and this License would be to refrain entirely from distribution of the Library.

If any portion of this section is held invalid or unenforceable under any particular circumstance, the balance of the section is intended to apply, and the section as a whole is intended to apply in other circumstances.

It is not the purpose of this section to induce you to infringe any patents or other property right claims or to contest validity of any such claims; this section has the sole purpose of protecting the integrity of the free software distribution system which is implemented by public license practices. Many people have made generous contributions to the wide range of software distributed through that system in reliance on consistent application of that system; it is up to the author/donor to decide if he or she is willing to distribute software through any other system and a licensee cannot impose that choice.

This section is intended to make thoroughly clear what is believed to be a consequence of the rest of this License.

12. If the distribution and/or use of the Library is restricted in certain countries either by patents or by copyrighted interfaces, the original copyright holder who places the Library under this License may add an explicit geographical distribution limitation excluding those countries, so that distribution is permitted only in or among countries not thus excluded. In such case, this License incorporates the limitation as if written in the body of this License.

13. The Free Software Foundation may publish revised and/or new versions of the Lesser General Public License from time to time. Such new versions will be similar in spirit to the present version, but may differ in detail to address new problems or concerns.

Each version is given a distinguishing version number. If the Library specifies a version number of this License which applies to it and "any later version", you have the option of following the terms and conditions either of that version or of any later version published by the Free Software Foundation. If the Library does not specify a license version number, you may choose any version ever published by the Free Software Foundation.

14. If you wish to incorporate parts of the Library into other free programs whose distribution conditions are incompatible with these, write to the author to ask for permission. For software which is copyrighted by the Free Software Foundation, write to the Free Software Foundation; we sometimes make exceptions for this. Our decision will be guided by the two goals of preserving the free status of all derivatives of our free software and of promoting the sharing and reuse of software generally.

NO WARRANTY

15. BECAUSE THE LIBRARY IS LICENSED FREE OF CHARGE, THERE IS NO WARRANTY FOR THE LIBRARY, TO THE EXTENT PERMITTED BY APPLICABLE LAW. EXCEPT WHEN OTHERWISE STATED IN WRITING THE COPYRIGHT HOLDERS AND/OR OTHER PARTIES PROVIDE THE LIBRARY "AS IS" WITHOUT WARRANTY OF ANY KIND, EITHER EXPRESSED OR IMPLIED, INCLUDING, BUT NOT LIMITED TO, THE IMPLIED WARRANTIES OF MERCHANTABILITY AND FITNESS FOR A PARTICULAR PURPOSE. THE ENTIRE RISK AS TO THE QUALITY AND PERFORMANCE OF THE LIBRARY IS WITH YOU. SHOULD THE LIBRARY PROVE DEFECTIVE, YOU ASSUME THE COST OF ALL NECESSARY SERVICING, REPAIR OR CORRECTION.

16. IN NO EVENT UNLESS REQUIRED BY APPLICABLE LAW OR AGREED TO IN WRITING WILL ANY COPYRIGHT HOLDER, OR ANY OTHER PARTY WHO MAY MODIFY AND/OR REDISTRIBUTE THE LIBRARY AS PERMITTED ABOVE, BE LIABLE TO YOU FOR DAMAGES, INCLUDING ANY GENERAL, SPECIAL, INCIDENTAL OR CONSEQUENTIAL DAMAGES ARISING OUT OF THE USE OR INABILITY TO USE THE LIBRARY (INCLUDING BUT NOT LIMITED TO LOSS OF DATA OR DATA BEING RENDERED INACCURATE OR LOSSES SUSTAINED BY YOU OR THIRD PARTIES OR A FAILURE OF THE LIBRARY TO OPERATE WITH ANY OTHER SOFTWARE), EVEN IF SUCH HOLDER OR OTHER PARTY HAS BEEN ADVISED OF THE POSSIBILITY OF SUCH DAMAGES.

END OF TERMS AND CONDITIONS

How to Apply These Terms to Your New Libraries

If you develop a new library, and you want it to be of the greatest possible use to the public, we recommend making it free software that everyone can redistribute and change. You can do so by permitting redistribution under these terms (or, alternatively, under the terms of the ordinary General Public License).

To apply these terms, attach the following notices to the library. It is safest to attach them to the start of each source file to most effectively convey the exclusion of warranty; and each file should have at least the "copyright" line and a pointer to where the full notice is found.

<one line to give the library's name and a brief idea of what it does.>
Copyright © <year> <name of author>

This library is free software; you can redistribute it and/or modify it under the terms of the GNU Lesser General Public License as published by the

Free Software Foundation; either version 2.1 of the License, or (at your option) any later version.

This library is distributed in the hope that it will be useful, but WITHOUT ANY WARRANTY; without even the implied warranty of MERCHANTABILITY or FITNESS FOR A PARTICULAR PURPOSE. See the GNU Lesser General Public License for more details.

You should have received a copy of the GNU Lesser General Public License along with this library; if not, write to the Free Software Foundation, Inc., 51 Franklin Street, Fifth Floor, Boston, MA 02110-1301 USA

Also add information on how to contact you by electronic and paper mail.

You should also get your employer (if you work as a programmer) or your school, if any, to sign a "copyright disclaimer" for the library, if necessary. Here is a sample; alter the names: Yoyodyne, Inc., hereby disclaims all copyright interest in the library 'Frob' (a library for tweaking knobs) written by James Random Hacker.

<signature of Ty Coon> , 1 April 1990
Ty Coon, President of Vice

That's all there is to it!

■ OpenSSL License

Copyright © 1998-2011 The OpenSSL Project. All rights reserved.

Redistribution and use in source and binary forms, with or without modification, are permitted provided that the following conditions are met:

1. Redistributions of source code must retain the above copyright notice, this list of conditions and the following disclaimer.

2. Redistributions in binary form must reproduce the above copyright notice, this list of conditions and the following disclaimer in the documentation and/or other materials provided with the distribution.

3. All advertising materials mentioning features or use of this software must display the following acknowledgment: "This product includes software developed by the OpenSSL Project for use in the OpenSSL Toolkit. (<http://www.openssl.org/>) "

4. The names "OpenSSL Toolkit" and "OpenSSL Project" must not be used to endorse or promote products derived from this software without prior written permission. For written permission, please contact openssl-core@openssl.org.

5. Products derived from this software may not be called "OpenSSL" nor may "OpenSSL" appear in their names without prior written permission of

the OpenSSL Project.

6. Redistributions of any form whatsoever must retain the following acknowledgment: "This product includes software developed by the OpenSSL Project for use in the OpenSSL Toolkit (<http://www.openssl.org/>) "

THIS SOFTWARE IS PROVIDED BY THE OpenSSL PROJECT ``AS IS'' AND ANY EXPRESSED OR IMPLIED WARRANTIES, INCLUDING, BUT NOT LIMITED TO, THE IMPLIED WARRANTIES OF MERCHANTABILITY AND FITNESS FOR A PARTICULAR PURPOSE ARE DISCLAIMED. IN NO EVENT SHALL THE OpenSSL PROJECT OR ITS CONTRIBUTORS BE LIABLE FOR ANY DIRECT, INDIRECT, INCIDENTAL, SPECIAL, EXEMPLARY, OR CONSEQUENTIAL DAMAGES (INCLUDING, BUT NOT LIMITED TO, PROCUREMENT OF SUBSTITUTE GOODS OR SERVICES; LOSS OF USE, DATA, OR PROFITS; OR BUSINESS INTERRUPTION) HOWEVER CAUSED AND ON ANY THEORY OF LIABILITY, WHETHER IN CONTRACT, STRICT LIABILITY, OR TORT (INCLUDING NEGLIGENCE OR OTHERWISE) ARISING IN ANY WAY OUT OF THE USE OF THIS SOFTWARE, EVEN IF ADVISED OF THE POSSIBILITY OF SUCH DAMAGE.

This product includes cryptographic software written by Eric Young (ey@cryptsoft.com) . This product includes software written by Tim Hudson (tjh@cryptsoft.com) .

Original SSLeay License

Copyright © 1995-1998 Eric Young (ey@cryptsoft.com) All rights reserved.

This package is an SSL implementation written by Eric Young (ey@cryptsoft.com) . The implementation was written so as to conform with Netscapes SSL.

This library is free for commercial and non-commercial use as long as the following conditions are aheared to. The following conditions apply to all code found in this distribution, be it the RC4, RSA, lhash, DES, etc., code; not just the SSL code. The SSL documentation included with this distribution is covered by the same copyright terms except that the holder is Tim Hudson (tjh@cryptsoft.com) .

Copyright remains Eric Young's, and as such any Copyright notices in the code are not to be removed. If this package is used in a product, Eric Young should be given attribution as the author of the parts of the library used.

This can be in the form of a textual message at program startup or in documentation (online or textual) provided with the package.

Redistribution and use in source and binary forms, with or without modification, are permitted provided

that the following conditions are met:

1. Redistributions of source code must retain the copyright notice, this list of conditions and the following disclaimer.

2. Redistributions in binary form must reproduce the above copyright notice, this list of conditions and the following disclaimer in the documentation and/or other materials provided with the distribution.

3. All advertising materials mentioning features or use of this software must display the following acknowledgement: "This product includes cryptographic software written by Eric Young (eay@cryptsoft.com) " The word 'cryptographic' can be left out if the routines from the library being used are not cryptographic related :-).

4. If you include any Windows specific code (or a derivative thereof) from the apps directory (application code) you must include an acknowledgement: "This product includes software written by Tim Hudson (tjh@cryptsoft.com) "

THIS SOFTWARE IS PROVIDED BY ERIC YOUNG ``AS IS'' AND ANY EXPRESS OR IMPLIED WARRANTIES, INCLUDING, BUT NOT LIMITED TO, THE IMPLIED WARRANTIES OF MERCHANTABILITY AND FITNESS FOR A PARTICULAR PURPOSE ARE DISCLAIMED. IN NO EVENT SHALL THE AUTHOR OR CONTRIBUTORS BE LIABLE FOR ANY DIRECT, INDIRECT, INCIDENTAL, SPECIAL, EXEMPLARY, OR CONSEQUENTIAL DAMAGES (INCLUDING, BUT NOT LIMITED TO, PROCUREMENT OF SUBSTITUTE GOODS OR SERVICES; LOSS OF USE, DATA, OR PROFITS; OR BUSINESS INTERRUPTION) HOWEVER CAUSED AND ON ANY THEORY OF LIABILITY, WHETHER IN CONTRACT, STRICT LIABILITY, OR TORT (INCLUDING NEGLIGENCE OR OTHERWISE) ARISING IN ANY WAY OUT OF THE USE OF THIS SOFTWARE, EVEN IF ADVISED OF THE POSSIBILITY OF SUCH DAMAGE.

The licence and distribution terms for any publically available version or derivative of this code cannot be changed. i.e. this code cannot simply be copied and put under another distribution licence

[including the GNU Public Licence.]

■ BSD License (libupnp)

Copyright © 2000-2003 Intel Corporation All rights reserved.

Redistribution and use in source and binary forms, with or without modification, are permitted provided that the following conditions are met:

* Redistributions of source code must retain the above copyright notice, this list of conditions and the following disclaimer.

* Redistributions in binary form must reproduce the above copyright notice, this list of conditions and

the following disclaimer in the documentation and/or other materials provided with the distribution.

* Neither name of Intel Corporation nor the names of its contributors may be used to endorse or promote products derived from this software without specific prior written permission.

THIS SOFTWARE IS PROVIDED BY THE COPYRIGHT HOLDERS AND CONTRIBUTORS ``AS IS'' AND ANY EXPRESS OR IMPLIED WARRANTIES, INCLUDING, BUT NOT LIMITED TO, THE IMPLIED WARRANTIES OF MERCHANTABILITY AND FITNESS FOR A PARTICULAR PURPOSE ARE DISCLAIMED. IN NO EVENT SHALL INTEL OR CONTRIBUTORS BE LIABLE FOR ANY DIRECT, INDIRECT, INCIDENTAL, SPECIAL, EXEMPLARY, OR CONSEQUENTIAL DAMAGES (INCLUDING, BUT NOT LIMITED TO, PROCUREMENT OF SUBSTITUTE GOODS OR SERVICES; LOSS OF USE, DATA, OR PROFITS; OR BUSINESS INTERRUPTION) HOWEVER CAUSED AND ON ANY THEORY OF LIABILITY, WHETHER IN CONTRACT, STRICT LIABILITY, OR TORT (INCLUDING NEGLIGENCE OR OTHERWISE) ARISING IN ANY WAY OUT OF THE USE OF THIS SOFTWARE, EVEN IF ADVISED OF THE POSSIBILITY OF SUCH DAMAGE.

 日立アプライアンス株式会社

〒105-8410 東京都港区西新橋 2-15-12 電話 (03)3502-2111